

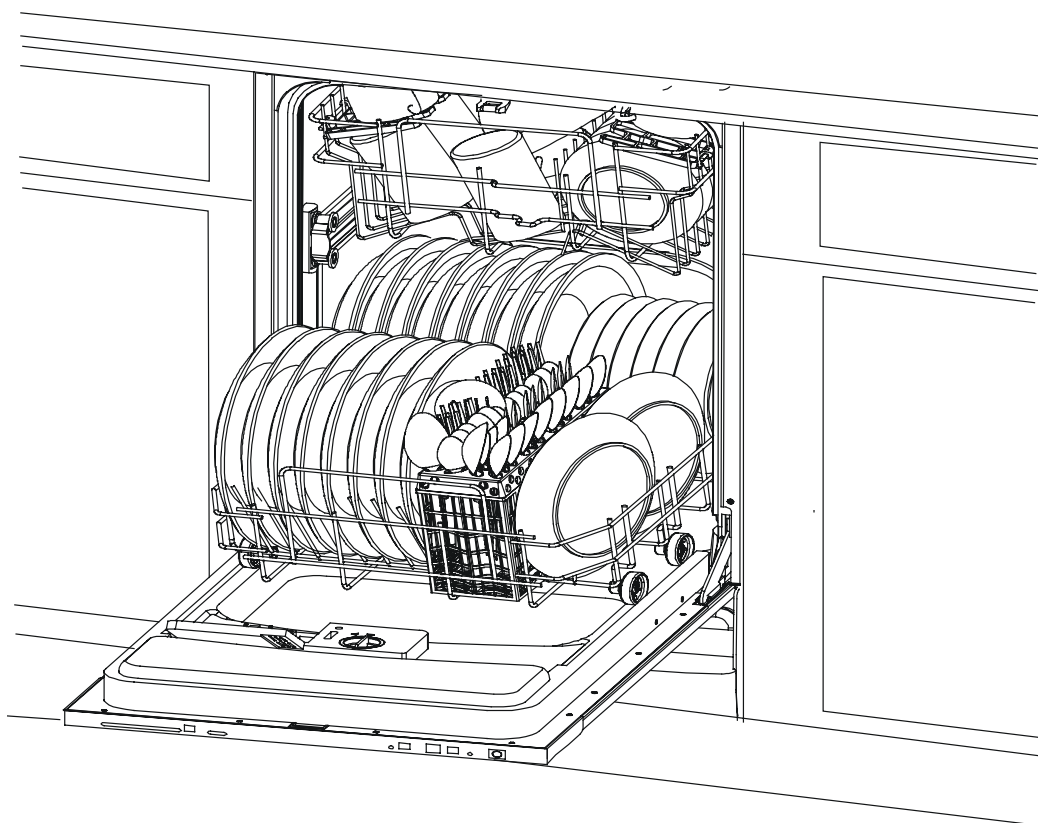

Dishwashers

Owner's Manual



Model SF 924

SAVE THESE INSTRUCTIONS

Dishwasher Features1

Safety Information 2

Operating Instructions

Control Panel 3

Dishwasher Features 3

Wash Cycle Table 4

Water Softener 5

Detergent 6

Rinse Aid 6

Loading the Dishwasher Rack 7

Silverware Basket 8

Filtering System 8

Turning On the Appliance 9

Caring for the Dishwasher 9,10

Troubleshooting Tips

Before calling for service 11,12

WARRANTY INFORMATION

Your Equator appliance is protected by this warranty under normal, personal, family or household use (1 Year), and limited commercial use (90 days) in the USA and Canada.

WARRANTY

Equator Corporation undertakes to the consumer-owner to repair or, at Equator Corporation's option, to replace any part of this product which proves to be defective in workmanship or material under normal personal, family or household use, in the USA and Canada, for a period of one year from the date of original purchase.

For commercial use, the product is warranted for a period of 90 days.

During this period, Equator Corporation will provide all labor and parts necessary to correct such defect, free of charge, if the appliance has been installed and operated in accordance with Equator Corporation's written instructions with the appliance. Ready access to the appliance, for service, is the responsibility of the consumer-owner.

EXCLUSIONS

In no event shall Equator Corporation be liable for incidental or consequential damages or for damages resulting from external causes such as abuse, misuse, incorrect voltage or acts God.

This warranty does not cover service calls which do not involve defective workmanship or materials covered by this warranty. Accordingly, diagnosis and repair costs for a service call which does not involve defective workmanship or materials will be the responsibility of the consumer-owner.

Specifically, the following work is not covered under warranty and does not constitute warranty work:

- . Installation – e.g. improper hook-up or leveling
- . Maintenance – e.g. cleaning of air and/or water filter
- . Damage – e.g. Replacing broken door handle

Most work is covered. The defining factor is, has the machine malfunctioned (Equator is responsible) or has the customer omitted or done something to cause machine to malfunction (customer is responsible). Some States do not allow the exclusion or limitation of incidental or consequential damages, so the above limitation or exclusion may not apply to you.

WARRANTY SERVICE

This warranty is given by:
Equator Corporation,
Equator Plaza,
2801 W. Sam Houston Pkwy. N.,
Houston, TX 77043-1611.

Service under this warranty must be obtained by the following steps, in order:

Call an Equator Corporation Authorized Service Agent (obtain number of nearest agent from your dealer or by calling Equator Service at 1-800-776-3538). Under normal circumstances, Service will be provided during regular business hours (9:00 a.m. to 5:00 p.m. weekdays).

GENERAL

Since it is responsibility of the consumer-owner to establish the warranty period by verifying the original purchase date, Equator Corporation recommends that a receipt, delivery slip or some other appropriate payment record be kept for that purpose.

Remember to send in your Warranty Registration Card so that a proof of your purchase exists with Equator. This warranty gives you specific legal rights, and you may also have other rights which vary from State to State.

Corporate Office

EQUATOR CORPORATION
Equator Plaza
2801 W. Sam Houston Pkwy. N.
Houston, TX 77043-1611
Tel: 713-464-3422 - Fax: 713-464-2151
Tel: 800-776-3538

DISHWASHER FEATURES

The electric dishwasher, based on the philosophy of technology is based on human being, besides the common characteristics of other household dishwashers, it has its own specialties:



Overflow protection

Your Midea dishwasher has an overflow protection program which could automatically shut off the inlet valve and start the drain pump if the water Overflows.



Salt Warning Indicator

If the salt is running low, there will be clearly displayed on the panel alerting you to top them up, to ensure that the machine continues to operate at optimum performance.



Time delay feature

This allows the start of the programme to be delayed between 1 and 9.5 hours, enabling you to benefit fully from cheaper electricity! Or just to benefit from the convenience of the programming finishing when you want to.



Rinse aid Warning Indicator

If the rinse aid is running low, there will be clearly displayed on the panel alerting you to top them up, to ensure that the machine continues to operate at optimum performance.



Error alarm

Fault codes displayed would inform the user of abnormal status of the machine.



Broad applied voltage

The broad scope of the applied voltage, reduces the code of electric condition.



Temperature display

Display the wash temperature at any moment. If you know the temperature of water, you will prevent from scalding when you open the door.



NOTE:

The manufacturer, following a policy of constant development and up-dating of the product, may make modifications without giving prior notice.



Stainless steel tub

You need not worry about stain of tub.



14 wash programs

You can choose desired program according to the soiled level. Such as, intensive wash, normal wash, economy, rinse, glass, rapid and pre-wash etc,



12 place settings

Be sufficient for normal use.



Adjustable upper basket

Even if the dishware are abnormality, you can load them by adjusting the upper basket.

IMPORTANT SAFETY INFORMATION

READ ALL INSTRUCTIONS BEFORE USING

WARNING!

When using your dishwasher, follow the below basic precautions including the following:

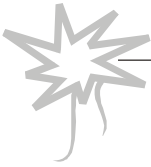

WARNING! HYDROGEN GAS IS EXPLOSIVE

Under certain conditions, Hydrogen gas may be produced in a hot-water system that has not been used for two weeks or more. HYDROGEN GAS IS EXPLOSIVE.

If the hot-water system has not been used for such a period, before using the dishwasher turn on all hot-water faucets and let the water flow from each for several minutes. This will release any accumulated hydrogen gas. As the gas is flammable, do not smoke or use an open flame during this time.



GROUNDING INSTRUCTIONS

- This appliance must be grounded. In the event of a malfunction or breakdown, grounding will reduce the risk of electric shock by providing a path of least resistance of electric current. This appliance is equipped with a cord having an equipment-grounding conductor and a grounding plug. The plug must be plugged into an appropriate outlet that is installed and grounded in accordance with all local codes and ordinances.

WARNING!

- Improper connection of the equipment-grounding conductor can result in a risk of electric shock. Check with a qualified electrician or service representative if you are in doubt whether the appliance is properly grounded. Do not modify the plug provided with the appliance ;if it is not fit for the outlet .have a proper outlet installed by a qualified electrician.



WARNING! PROPER USE

- Do not abuse, sit on, or stand on the door or dish rack of the dishwasher.
- Do not touch the heating element during or immediately after use.
- Do not wash plastic items unless they are marked dishwasher safe or the equivalent. For plastic items not so marked, check the manufactures recommendations.
- Use only detergent and rinse additives designed for an automatic dishwasher. Never use soap , laundry detergent, or hand washing detergent in your dishwasher. Keep these products out of children.
- Keep child away from detergent and rinse aid, keep child away from the open door of the dishwasher, there could still be some detergent left inside.
- The door should not be left in the open position since this could present a tripping hazards.
- During installation, the power supply must not be excessively or dangerously bent or flattened.
- Do not tamper with controls.
- The appliance is not intended for use by young children or infirm persons without supervision.
- Dishwasher detergents are strongly alkaline,they can be extremely dangerous if swallowed. Avoid contact with skin and eyes and keep children away from the dishwasher when the door is open.
- Do not operate your dishwasher unless all enclosure panels are properly inplace. Open the door very carefully if the dishwasher is operating, there is a risk of water squirting out.
- Do not place any heavy objects of stand on the door when it is open. The appliance could tip forward.
- When loading items to be washed:
 - 1) Locate sharp items so that they are not likely to damage the door seal;
 - 2) Load sharp knives with the handles up to reduce the risk of cut-type injuries.
- When using your dishwasher, you should prevent plastic item from contacting with heating element.
- If the supply cord is damaged, it must be replaced by the manufacturer or its service agent or a similarly qualified person in order to avoid a hazard.
- Please dispose of packing materials properly.
- Use the dishwasher only for its intended function.
- Remove the door to the washing compartment when removing an old dishwasher from service or discarding it.
- Young children should be supervised to ensure that they do not play with the appliance.
- Check that the detergent receptable is empty after completion of the wash cycle.

READ AND FOLLOW THIS SAFETY INFORMATION CAREFULLY

SAVE THESE INSTRUCTIONS

IMPORTANT!

To get the best performance from your dishwasher, read all operating instructions before using it for the first time.

Control Panel

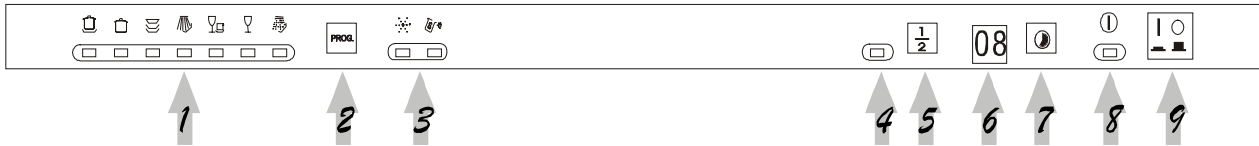





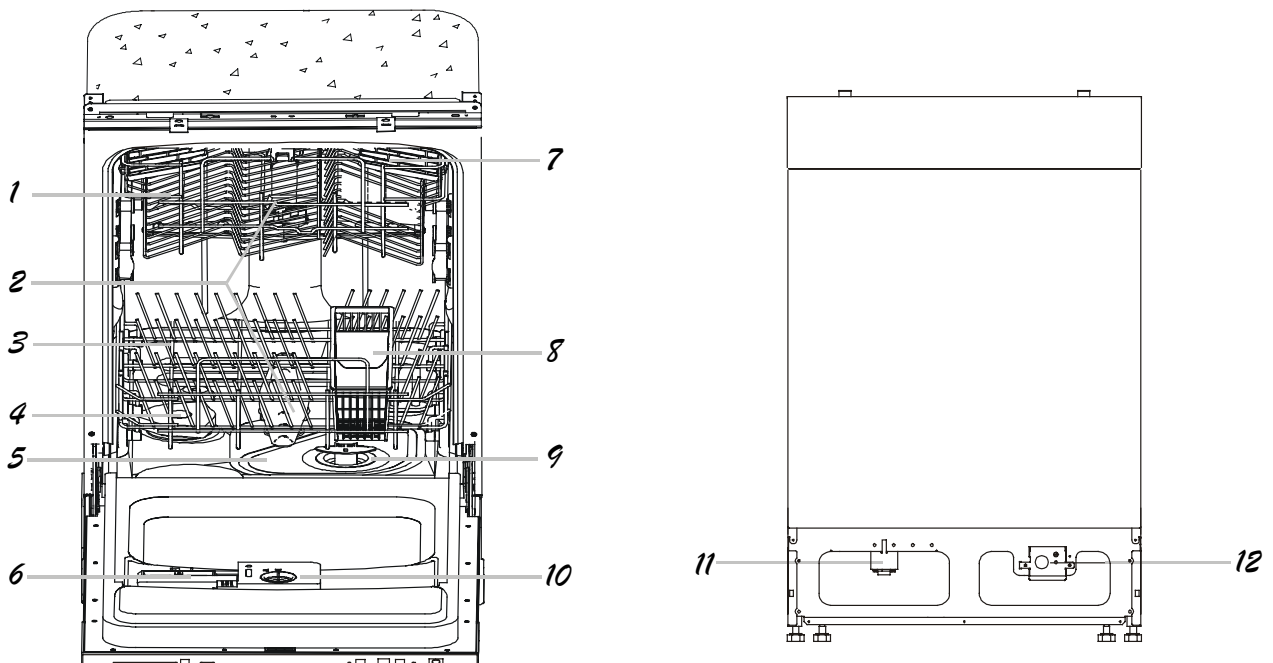

- | | |
|---|---|
| <p>1 Program indicator light: when you select washing program, the correspond light will display.</p> <p>2 Program Key—press: To select washing program when press the Program Key—press.</p> <p>3 Salt and Rinse Aid Warning Light: To come on when the softener or dispenser needs to be refilled (Certain model only).</p> <p>4 Half washing light: To come on when select the Half wash, (option)</p> | <p>5 Half washing key—press: To select half washing. (Optional half washing means that the lower spray arm does not run, so you should load the upper basket only).</p> <p>6 Delay start time: To display booking time or the washing temperature.</p> <p>7 Delay key—press: The key to set the delay start time.</p> <p>8 Power on light: To come on when Power ON/OFF Button is pressed down.</p> <p>9 ON/OFF Button: To turn on/off the power supply.</p> |
|---|---|

Dishwasher Features



- | | | | |
|---------------------|------------------------------|----------------------------|-------------------------------|
| 1 Upper Rack | 4 Water Softener | 7 Cup Shelf | 10 Rinse Aid Dispenser |
| 2 Spray Arms | 5 Main Filter | 8 Silverware Basket | 11 Inlet Valve |
| 3 Lower Rack | 6 Detergent Dispenser | 9 Coarse Filter | 12 Junction Box |

WASH CYCLE TABLE

Program	Cycle	Plus Button	Rapid Button	Cycle Selection Information	Description of Cycle	Detergent pre/main	Rinse Aid
Normal				For normally soiled loads, such as pots, plates, glasses and lightly soiled pans. standard daily cycle.	Pre-rinse Pre-rinse Wash (50 °C) Rinse Rinse (65 °C) Drying	5/22 gr.	★
Intensive		★		For the heaviest soiled loads, such as pots, pans, casserole dishes and dishes that have been sitting with dried food on them for a while.	Pre-rinse Pre-rinse (50 °C) Wash (60 °C) Rinse Rinse (70 °C) Drying	5/22 gr.	★
Economy				For lightly soiled loads, such as plates, glasses, bowls and lightly soiled pans.	Pre-rinse Wash (50 °C) Rinse Rinse (65 °C) Drying	22 gr.	★
Rinse				For dishes that need to be rinsed and dried only.	Rinse Rinse (65 °C) Drying		★
Light				For lightly soiled loads, such as glasses, crystal and fine china.	Pre-rinse Wash (40 °C) Rinse Rinse (65 °C)	15 gr.	★
Rapid			★	A shorter wash for lightly soiled loads that do not need drying.	Wash (40 °C) Rinse Rinse (55 °C)	15 gr.	
Soak				To rinse dishes that you plan to wash later that day.	Pre-rinse		

Overfill Protection

Your Midead dishwasher has an overfill protection device which could automatically shuts off the inlet valve and starts the drain pump if the water overflow. If this occurs, turn off the main water supply before calling a servicing. If there is water in the base pan because of an overfill or small leak, the water should be removed before restarting the dishwasher.

NOTE: If your model have not water softener, you may skip this section.

WATER SOFTENER

There are two ways to reduce the water hardness: one way is using water softener, the other is using detergent.

The hardness of the water varies from place to place. If hard water is used in the dishwasher, deposits will form on the dishes and utensils.

The appliances is equipped with a special softener that uses a salt specifically designed to eliminate lime and minerals from the water.

Loading the Salt into the Softener

Always use salt intended for use with dishwashers.

The salt container is located beneath the lower rack and should be filled as follows:

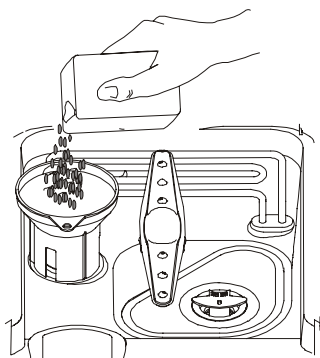

- 1 Remove the lower basket and then unscrew and remove the cap from the salt container.
- 2 If you are filling the container for the first time, fill 2/3 of its volume with water.
- 3 Place the end of the funnel (supplied) into the hole and introduce about 2kg of salt. It is normal for a small amount of water to come out of the salt container.
- 4 Carefully screw the cap back on.

- NOTE:**
1. The salt container must be refilled when the salt warning light comes on. Though the salt container is filled enough, the indicator light may not black out before the salt fully dissolve.
 2. If there are spills of the salt, a soak program could be run to wipe them out.

Adjusting Salt Consumption

The dishwasher is designed to allow for adjusting the amount of salt consumed based on the hardness of the water used. This is intended to optimize and customize the level of salt consumption so that the salt consumption could be set proceed as follows:

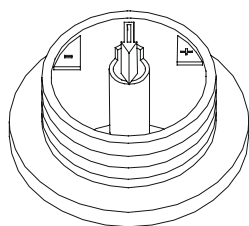

- 1 Unscrew the cap from the salt container.
- 2 There is a ring on the container with an arrow on it (see Figure to the side), if necessary, rotate the ring in the anticlockwise direction from the "-" Setting toward the "+" sign, based on the hardness of the water being used. It is recommended that adjustments should be made in accordance with the following schema:

WATER HARDNESS			Selector Position	Salt consumption (gram/cycle)
Clarke Degrees	°dH	mmol/l		
0~14	0~10	0~1.7	-	0
14~36	18~44	1.8~4.4	/	20
36~71	45~89	4.5~8.9	MED	40
71	89	8.9	+	60

Contact your local water board for information on the hardness of your water supply.

DETERGENT DISPENSER

YOU MAY NOT ADD TOO MUCH DETERGENT TO PREVENT THE FORMATION OF DEPOSITS BECAUSE YOUR DISHWASHERS HAVE SPECIALLY-DESIGNED WATER SOFTENERS.

The dispenser must be refilled before the start of each wash cycle following the instructions provided in the "Wash Cycle Table". Your dishwashers use less detergent and rinse aid than conventional dishwashers. Generally, only one tablespoon of detergent is needed for a normal wash load. Also, more heavily soiled items need more detergent. Always add the detergent just before starting dishwasher, otherwise it could get damp and will not dissolve properly.

Amount of Detergent to Use

IF THE WATER ISN'T TOO HARD, YOU MAY ALSO PREVENT THE FORMATION OF DEPOSITS BY ADDING DETERGENT. The amount of detergent needed can vary due to differences in water hardness. To determine the water hardness in your area, contact your local water utility or area water softening company. The harder the water, the more detergent you may need. Remember, you should adjust the amount of detergent you use by small amounts until you find the correct amount.

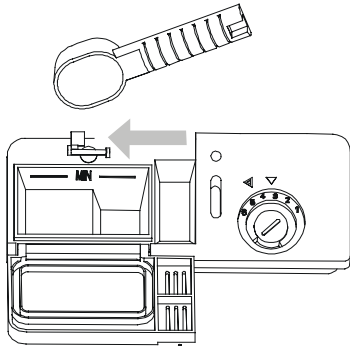

⚠ WARNING!

Dishwasher detergent is corrosive! Take care to keep it out of reach of children.

Removing Hard Water Spots

To remove hard water spots, try the following:

- Run dishes through a normal wash program.
- Remove all metal dishware, such as cutlery, pans, etc., from the dishwasher.
- Do not add detergent.
- Pour two cups of vinegar into a bowl and set the bowl face up on the lower rack of the dishwasher.
- Run the dishes through a normal wash program.

If this doesn't work, try the same process with 1 / 4 cup of citric acid crystals instead of vinegar.

Proper Use of Detergent

Use only detergent specifically made for use in dishwashers. Keep your detergent fresh and dry. Don't put powder detergent into the dispenser until you're ready to wash dishes.

RINSE AID DISPENSER

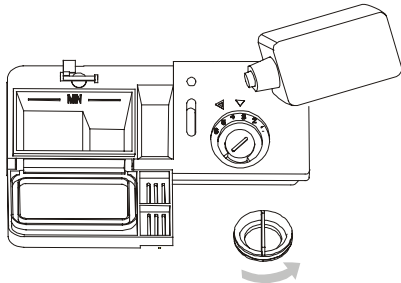

- To open the dispenser, turn the cap to the "open" (left) arrow and lift it out.
- Pour the rinse aid into the dispenser, being careful not to overfill.
- Replace the cap by inserting it aligned with "open" arrow and turning it to the closed (right) arrow.

The rinse aid is released during the final rinse to prevent water from forming droplets on your dishes that can leave spots and streaks. It also improves drying by allowing water to "sheet" off the dishes.

Your dishwashers are designed to use liquid rinse aids. The rinse aid dispenser is located inside the door next to the detergent dispenser. To fill the dispenser, open the cap and pour the rinse aid into the dispenser until the level indicator turns completely black. The dispenser holds about 100 ml of liquid rinse aid.

Be careful not to overfill the dispenser, because this could cause oversudsing. Wipe away any spills with a damp cloth. Don't forget to replace the cap before you close the dishwasher door.

If you have soft water, you may not need rinse aid for it may cause a white film to develop on your dishes.

Adjusting Rinse Aid Dispenser

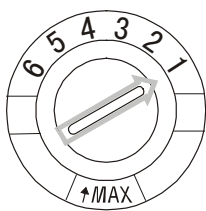

A measured amount of rinse aid is released during the final rinse. As with detergent, the amount of rinse aid needed for your dishes depends on the hardness of the water in your area. Too much rinse aid can result in lather of foaming and cause cloudiness or streaks on your dishes. If the water in your area is very soft, you may not need rinse aid. If you do, you can dilute the rinse aid with an equal amount of water.

The rinse aid dispenser has six settings. Always start with the dispenser set on "1". If spots and poor drying are problems, increase the amount of rinse aid dispensed by removing the dispenser lid and rotating the dial to "2". If the dishes still are not drying properly or are spotted, adjust the dial to the next higher number until your dishes are spot-free. We suggest you to set on "4".

When to Refill the Rinse Aid Dispenser

If there is no rinse aid warning light in the control panel, you can judge the amount of rinse aid by the following means. The black dot on the rinse aid dispenser indicates the amount of rinse aid in the dispenser. As the rinse aid diminishes, the size of the black dot decreases. You should never let the rinse aid get below 1 / 4 full.

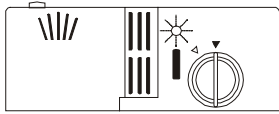

As the rinse aid diminishes, the size of the black dot on the rinse aid level indicator changes, as illustrated below.

- Full
- 3 / 4 full
- 1 / 2 full
- 1 / 4 full – Should refill to eliminate spotting
- Empty

Loading the Dishwasher Racks.

For best performance of the dishwasher, follow these loading guidelines. Features and appearance of racks and silverware baskets may vary from your model.

How to use the Upper Rack

The upper rack is designed to hold more delicate and lighter dishware such as glasses, coffee and tea cup and saucers, as well as plates, small bowls and shallow pans (as long as they are not too dirty).

Position the dishes and cookware so that they do not get moved by the spray of water.

The upper rack can be adjusted for height by putting wheels of different height into the rails.

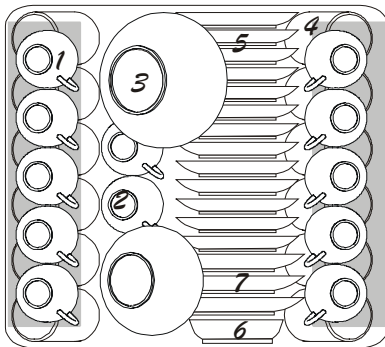

- 1 Cups
- 2 Small serving bowl
- 3 Large serving bowl
- 4 Glasses
- 5 Saucers
- 6 Dish
- 7 Plates

How to use the Lower Rack

We recommend that you place large items which are most difficult to clean into the lower rack: pots, pans, lids, serving dishes and bowls, as shown in the figure to the right.

It is preferable to place serving dishes and lids on the side of the racks in order to avoid blocking the rotation of the top spray arm.

- Pots, serving bowls, etc, must always be placed top down.
- Deep pots should be slanted to allow water to flow out.
- The bottom rack feature fold down tine rows so that larger or more pots and pans can be loaded.

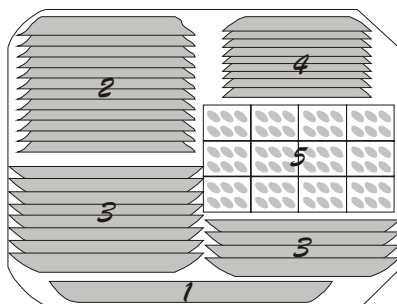

- 1 Oval platter
- 2 Dinner plates
- 3 Soup plates
- 4 Dessert dishes
- 5 Silverware basket

SILVERWARE BASKET

Silverware should be placed in the silverware basket with handles at the bottom: If the rack has side baskets, the spoon should be loaded individually into the appropriate slots, Especially long utensils should be placed in the horizontal position at the front of the upper rack.

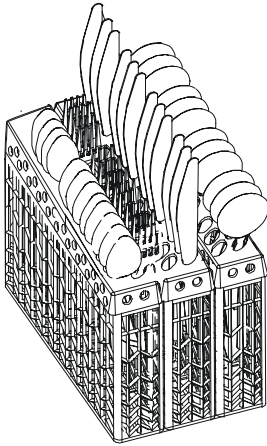

4 1	5 3	3 2
4 1	5 3	3 2
4 1	5 3	3 2
4 1	5 3	3 2
4 1	5 3	3 2
4 1	5 3	3 2
4 1	5 6	8 2
4 1	5 7	6 2

- | | |
|------------------|-----------------|
| 1 Forks | 5 Knife |
| 2 Soup spoons | 6 Serving spoon |
| 3 Dessert spoons | 7 Gravy ladle |
| 4 Teaspoons | 8 Serving fork |



▲ WARNING!

Do not let any item extend through bottom.

Turning on the Appliance

Starting a wash cycle. . .

- 1 Make sure that the plug of the appliance is inserted into the wall socket.
- 2 Make sure that the water supply is turned on to full pressure.
- 3 Load the dishwasher (see the section entitled, "Loading the Dishwasher").
- 4 Pour in the detergent (see the section entitled, "Salt, Detergent and Rinse Aid").
- 5 Open the door, press the ON/OFF button, and the ON/OFF light will turn on.
- 6 Press the "prog key-press" to select the "Wash cycle". (see the section entitled, "Wash Cycle Table".)
- 7 Close the door, the washing will start after ten second.

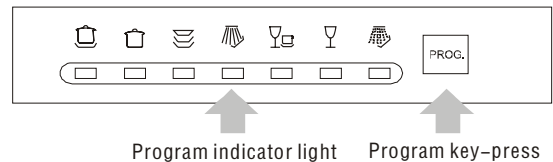

Canceling or modifying a wash cycle setting. . .

Premise: A cycle that is underway can only be modified if it has only been running for a short time. Otherwise, the detergent may have already been released, and the appliance may have already drained the wash water. If this is the case, the detergent dispenser must be refilled (see the paragraph entitled "Loading the Detergent").
Open the door, Press the "Prog key-press" more than three second, then you can change the program to the desired cycle setting (see the section entitled, "Starting a wash cycle. . ."). Then, close the door.

At the End of the Wash Cycle

When the washing cycle has finished, the buzzer of dishwasher will moong eight second, then stop. Turn off the appliance using the ON/OFF button, open the door of the dishwasher. Wait a few minutes before unloading the dishwasher to avoid handling the dishes and utensils while they are still hot and more susceptible to breakage. They will also dry better.

Forget to Add a Dish?

A forgotten dish can be added any time before the detergent cup opens.

- | | |
|--|--|
| 1 Open the door a little to stop the washing. | 3 Add forgotten dishes. |
| 2 After the spray arms stop working, you can open the door completely. | 4 Close the door, the dishwasher will work after ten second. |

▲ WARNING!

It is dangerous to open the door when washing, because the hot water may be scalded to you.

Filtering System

For your convenience, we have placed the drain pump and filtering system within easy reach inside the tub. There are three components of the filtering system: the main filter, the coarse filter, and the fine filter.

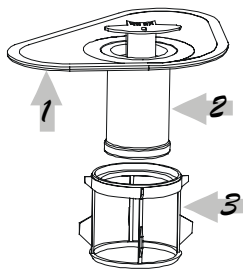

- 1 Main filter**
Food and soil particles trapped by this filter are pulverized by a special jet on the lower spray arm and washed down the drain.
- 2 Coarse filter**
Larger items, such as pieces of bone or glass, that could clog the drain are trapped in the coarse filter. To remove an item caught in this filter, gently squeeze the tabs on top of this filter and lift it out.
- 3 Fine filter**
This filter holds soil and food residue in the sump area and prevents it from being redeposited on the dishes during a cycle.

Caring for the Dishwasher

To clean the control panel use a lightly dampened cloth then dry thoroughly. To clean the exterior use a good appliance polish wax.

Never use sharp objects, scouring pads or harsh cleaners on any part of the dishwasher.

Protect Against Freezing

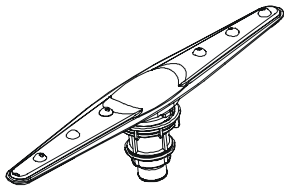

If your dishwasher is left in an unheated place during the winter, ask a service technician to:

- 1** Cut off electrical power to the dishwasher. Remove fuses or trip circuit breaker.
- 2** Turn off the water supply and disconnect the water inlet pipe from the water valve.
- 3** Drain water from the inlet pipe and water valve. (Use a pan to catch the water.)
- 4** Reconnect the water inlet pipe to the water valve.
- 5** Remove the plastic sump cover in the tub the bottom and use a sponge to soak up water in rubber boot.

Cleaning the Spray Arms

It is necessary to clean the spray arms regularly for hard water chemicals will clog the spray arm jets and bearings. To remove the spray arm, screw off the nut to take out the washer on top of the spray arm and remove the arm. Wash the arms in soapy and warm water and use a soft brush to clean the jets. Replace them after rinsing them thoroughly.

Cleaning the Filters

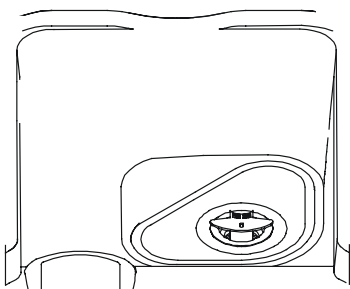

Filter assembly

For best performance and results, the filter assembly must be cleaned.

The filter efficiently removes food particles from the wash water, allowing it to be recirculated during the cycle. For this reason, it is a good idea to remove the larger food particles trapped in the filter after each wash cycle by rinsing the semicircular filter and cup under running water. To remove the filter assembly, pull on the cup handle in the upward direction. The entire filter assembly should be cleaned at least once a month.

To clean the coarse filter and the fine filter, use a cleaning brush. Then, reassemble the filter parts as shown in the figures left and reinsert the entire assembly in the dishwasher, positioning in its seat and pressing downward.

The dishwasher must never be used without the filters. Improper replacement of the filter may reduce the performance level of the appliance and damage dishes and utensils.

⚠ WARNING!

Never run the dishwasher without the filters in place.

User–Maintenance Instructions

Cleaning the Door

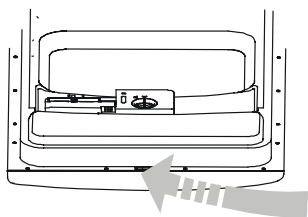

To clean the edge around the door, you should use only a soft warm, damp rag. To prevent penetration of water into the door lock and electrical components, do not use a spray cleaner of any kind.

Also, never use abrasive cleaners or scouring pads on the outer surfaces because they will scratch the finish. Some papers towels can also scratch or leave marks on the surface.

⚠ WARNING!

Never use a spray cleaner to clean the door panel for it could damage the door lock and electrical components. It is not allowed to use the abrasive agent or some paper towel because of the risk of scratching or leaving spots on the stainless steel surface.

Cleaning the Drain Pump

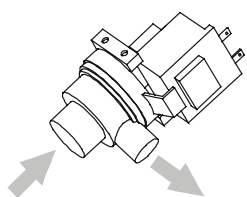

Something will occasionally move into the filters and the drain pump. If this occurs, the drain pumps employed in your dishwashers are designed to automatically reverse, ejecting the item back into the sump area or down the drain. If you have to remove an obstacle from the drain pump, before you remove the filters, you should turn off the power; Then remove the small black insert from the sump area. (You might want to remove any standing water first). Scoop out the item that is probably in the sump area and causes the obstruction. Remember to replace the black insert before you put the filters back in.

How to Keep Your Dishwasher in Shape

■ **After Every Wash**

After every wash, turn off the water supply to the appliance and leave the door slightly ajar so that moisture and odors are not trapped inside.

■ **Remove the Plug**

Before cleaning or performing maintenance, always remove the plug from the socket. Do not run risks.

■ **No Solvents or Abrasive Cleaning**

To clean the exterior and rubber parts of the dishwasher, do not use solvents or abrasive cleaning products. Rather, use only a cloth and warm soapy water. To remove spots or stains from the surface of the interior, use a cloth dampened with water and a little white vinegar, or a cleaning product made specifically for dishwashers.

■ **When You Go on Holiday**

When you go on holiday, it is recommended that you run a wash cycle with the dishwasher empty and then remove the plug from the socket, turn off the water supply and leave the door of the appliance slightly ajar. This will help the seals last longer and prevent odors from forming within the appliance.

■ **Moving the Appliance**

If the appliance must be moved, try to keep it in the vertical position. If absolutely necessary, it can be positioned on its back.

■ **Seals**

One of the factors that cause odors to form in the dishwasher is food that remains trapped in the seals. Periodic cleaning with a damp sponge will prevent this from occurring.

About Electricity Connecting

⚠ CAUTION, for personal safety:

DO NOT USE AN EXTENSION CORD OR AN ADAPTER PLUG WITH THIS APPLIANCE.

DO NOT, UNDER ANY CIRCUMSTANCES, CUT OR REMOVE THE THIRD GROUNDING PRONG FROM THE POWER CORD.

Electrical Requirements

This dishwasher is designed for operation on an adequately wired individual 220~240VAC, 50Hz. Use required fuse 15 amps. Fused electrical supply is required—copper wire only. Time delay fuse or circuit breaker recommended and provide separate circuit serving only this appliance. Outlet should be placed in adjacent cabinet.

Electrical Connection

After making sure that the voltage and the frequency values for the current in the home correspond to those on the rating plate and that the electrical system is sized for the maximum voltage on the rating plate, insert the plug into an electrical socket which is earthed properly. If the electrical socket to which the appliance must be connected is not appropriate for the plug, replace the socket, rather than using an adaptor or the like as they could cause overheating and burns.

⚠ WARNING!

Insure proper ground exists before use

User–Maintenance Instructions

Before Calling for service . . .

Troubleshooting Tips

Review the charts on the following pages may make you be free of calling for service.



<i>Problem</i>	<i>Possible Causes</i>	<i>What To Do</i>
<i>Dishwasher doesn't run</i>	Fuse blown, or the circuit breaker acted	Replace fuse or reset circuit breaker. Remove any other appliances sharing the same circuit with the dishwasher
	Power supply is not turned on	Make sure the dishwasher is turned on and the door is closed securely. Make sure the power cord is properly plugged into the wall socket.
	Water pressure is low	Check that the water supply is connected properly and the water is turned on.
<i>Drain pump doesn't stop</i>	Overflow	The system is designed to detect an overflow. When it does, it shuts off the circulation pump and turns on the drain pump.
<i>Noise</i>	Some audible sounds are normal	Sound from soft food shredding action and detergent cup opening.
	Utensils are not secure in the baskets or something small has dropped into the basket	To ensure everything is secured in the dishwasher.
	Motor hums	Dishwasher has not been used regularly. If you do not use it often, remember to set it to fill and pump out every week, which will help keep the seal moist.
<i>Suds in the tub</i>	Improper detergent	Use only the special dishwasher detergent to avoid suds. If this occurs, open the dishwasher and let suds evaporate. Add 1 gallon of cold water to the tub. Close and latch the dishwasher, then drain out the water by slowly turning the Dial until a drain period is reached. Repeat if necessary.
	Spilled rinse agent	Always wipe up rinse agent spills immediately.
<i>Stained tub interior</i>	Detergent with colorant was used	Make sure that the detergent is the one without colorant.
<i>Dishes are not dried</i>	Rinse agent dispenser is empty	Make sure that the rinse agent dispense is filled.
<i>Dishes and flatware not clean</i>	Improper program	Select stronger program
	Improper rack loading	Make sure that the action of the detergent dispenser and spray arms are not blocked by large dishware.
<i>Spots and filming on glasses and flatware</i>	<ul style="list-style-type: none"> 1 Extremely hard water 2 Low inlet temperature 3 Overloading the dishwasher 4 Improper loading 5 Old or damp powder detergent 6 Empty rinse agent dispenser 7 Incorrect dosage of detergent 	<ul style="list-style-type: none"> • To remove spots from glassware: <ul style="list-style-type: none"> 1 Take out all metal utensils out of the dishwasher. 2 Do not add detergent. 3 Choose the longest cycle. 4 Start the dishwasher and allow it to run for about 18 to 22 minutes, then it will be in the main wash. 5 Open the door to pour 2 cups of white vinegar into the bottom of the dishwasher. 6 Close the door and let the dishwasher complete the cycle. If the vinegar does not work: Repeat as above, except use 1/4 cup (60 ml) of citric acid crystals instead of vinegar.

User–Maintenance Instructions Before calling for service . . .

<i>Problem</i>	<i>Possible Causes</i>	<i>What To Do</i>
<i>Cloudiness on glassware</i>	Combination of soft water and too much detergent	Use less detergent if you have soft water and select a shortest cycle to wash the glassware and to get them clean.
<i>Yellow or brown film on inside surfaces</i>	Tea or coffee stains	using a solution of 1/2 cup of bleach and 3 cups warm water to remove the stains by hand. ▲ WARNING You have to wait for 20 minutes after a cycle to let the heating elements cool down before cleaning interior; otherwise, burns will happen.
	Iron deposits in water can cause an overall film	You have to call a water softener company for a special filter.
<i>White film on inside surface</i>	Hard water minerals	To clean the interior, use a damp sponge with dishwasher detergent and wear rubber gloves. Never use any other cleaner than dishwasher detergent for the risk of foaming or suds.
<i>Detergent cup lid won't latch</i>	Dial is not in the OFF position	Turn the Dial to OFF position and slide the door latch to the left.
<i>Detergent left in dispenser cups</i>	Dishes block detergent cups	Re-loading the dishes properly.
<i>Steam</i>	Normal phenomenon	There is some steam coming through the vent by the door latch during drying and water draining.
<i>Black or gray marks on dishes</i>	Aluminum utensils have rubbed against dishes	Use a mild abrasive cleaner to eliminate those marks.
<i>Water standing in the bottom of the tub</i>	This is normal	A small amount of clean water around the outlet on the tub bottom at the back of the tub keeps the water seal lubricated.
<i>Dishwasher leaks</i>	Overfill dispenser or rinse aid spills	Be careful not to overfill the rinse aid dispenser. Spilled rinse aid could cause oversudsing and lead to overflowing. Wipe away any spills with a damp cloth.
	Dishwasher isn't level	Make sure the dishwasher is level.

EQUATOR CONTACT NUMBER

PARTS & SERVICE: (800) 776-3538



Equator Corporation
Equator Plaza
2801 W. Sam Houston Parkway N.
Houston, Texas 77043-1611
Tel: 713-464-3422 Fax: 713-464-2151
Toll Free: 800-935-1955
All Rights Reserved
Manual subject to change without notice